

PRODUCT DATA SHEET

Tolomeo Floor Mega - LED - Black - Dimmer



DESIGN BY :

MicheleDe Lucchi,GiancarloFassina
2013

MATERIALS :

Polished aluminium, fabric and plastic

DESCRIPTION :

Black polished aluminium base and cantilevered arms; diffuser in black fabric on a plastic/metallic frame; joints in polished aluminium. Diffuser adjustable in all directions. System of spring balancing.

Diffuser available in three sizes.

Light emission

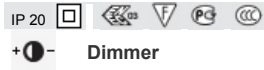

TECHNICAL DATA SHEET

FEATURES

Product name:	Tolomeo Floor Mega - LED - Black - Dimmer
Article Code:	0761030A
Colour:	Black
Material:	Polished aluminium, fabric and plastic
Support:	Base
Support colour:	Black
Series:	Design

DIMENSIONS

Length:	cm 107
Height:	cm 148
Cutout width:	cm 36
Base Diameter:	cm 33
Max Extension Height:	cm 330
Max Extension Length:	cm 190
Cutout shape:	

LAMPS INCLUDED

Category:	LED
Watt:	31
Luminous Flux (lm):	3454
Typology:	2
Color temperature (K):	3000
Class:	A

DIMENSIONS

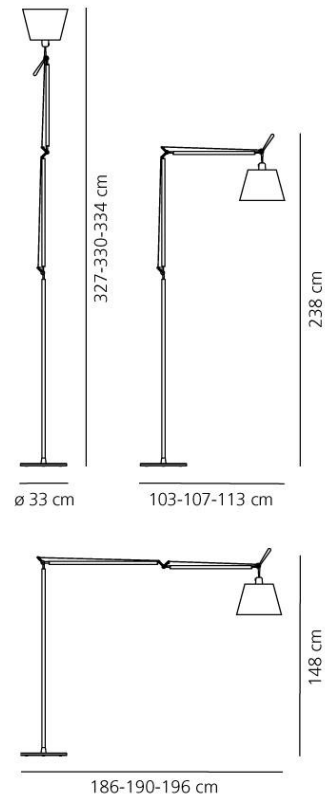

LAMP



+ 0 - Dimmer

LUMINAIR

Watt: 31 W
Voltage: 220V-240V

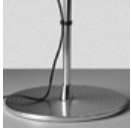

TOLOMEO MEGA LED
BASE+ASTA0763010A



TOLOMEO MEGA LED
BASE+ASTA
NERO0763030A



TOLOMEO MEGA
DIFF.PERG.3200780010A



TOLOMEO MEGA
DIFF.PERG.3600780020A



TOLOMEO MEGA
DIFF.PERG.4200780030A



TOLOMEO MEGA
DIFF.RASO 3200781010A



TOLOMEO MEGA
DIFF.RASO 3600781020A



TOLOMEO MEGA
DIFF.RASO 4200781030A



TOLOMEO MEGA
DIFF.TESSUTO NRO
D.3200772010A



TOLOMEO MEGA
DIFF.TESSUTO NRO
D.3600772020A



TOLOMEO MEGA
DIFF.TESSUTO NRO
D.4200772030A

ACCESSORIES

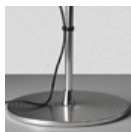

TOLOMEO MEGA LED
BASE+ASTA0763010A



TOLOMEO MEGA LED
BASE+ASTA
NERO0763030A

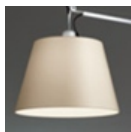

TOLOMEO MEGA
DIFF.PERG.3200780010A

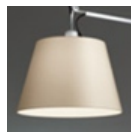

TOLOMEO MEGA
DIFF.PERG.3600780020A

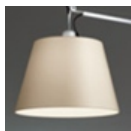

TOLOMEO MEGA
DIFF.PERG.4200780030A



TOLOMEO MEGA
DIFF.RASO 3200781010A



TOLOMEO MEGA
DIFF.RASO 3600781020A



TOLOMEO MEGA
DIFF.RASO 4200781030A



TOLOMEO MEGA
DIFF.TESSUTO NRO
D.3200772010A



TOLOMEO MEGA
DIFF.TESSUTO NRO
D.3600772020A



TOLOMEO MEGA
DIFF.TESSUTO NRO
D.4200772030A